



CAMO  
**BLOCK™**

# INSTALLATION GUIDE



# CAMO BLOCK™

## The Better Floating Foundation.

Build a better freestanding deck from the ground up. If you're building a freestanding deck 5½ in. to 30 in. tall, there's no better solution than CAMO Block™.



**2 IN. CHANNEL FOR METAL JOISTS**



**6X6 POST SETTING**



**4X4 POST SETTING**

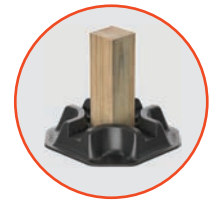

**RIBS DIRECT WATER AWAY FROM THE JOIST OR POST**

**1½ IN. CHANNEL FOR STANDARD 2X JOISTS**



**WEIGHS  
2.16 LBS**



**WIDE FOOTPRINT ALLOWS FOR SPATIAL DISPERSION AND STABILITY**

**WEEP HOLES FOR WATER DRAINAGE**

**17 1/8 IN.**

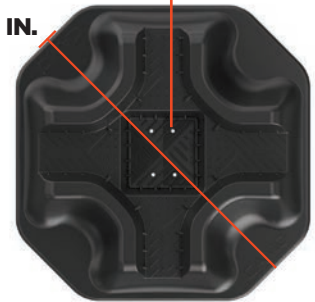

**15 3/4 IN.**

### USE BLOCK FOR VARIOUS PLATFORM PROFILES AND PROJECTS

**LOW-PROFILE**



**FREESTANDING DECKS**

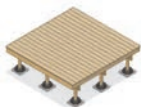

**RAISED-PROFILE**



**ROOF TOP DECKS**



**VARIABLE-HEIGHT**



**LANDINGS**



**WALKWAYS**



**HYBRID-PROFILE**



**SHEDS**



**DOG HOUSES**



## Best Practice Installation

To build a strong foundation for your project that will last, follow the steps below.

- 1 Remove at least 2 in. of top soil

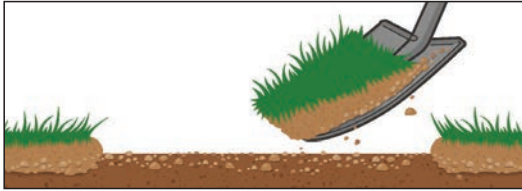

- 2 Fill with 3 in. of paver base material

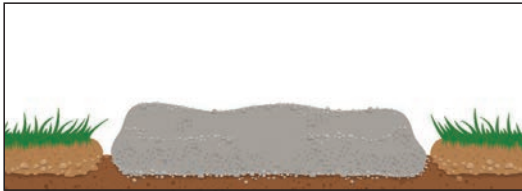

- 3 Compact the paver base until level

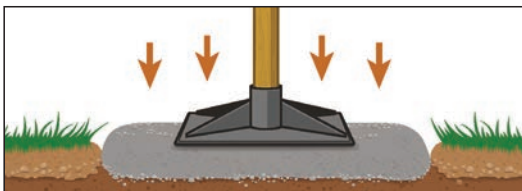

- 4 Place BLOCK, check that it's level, and adjust as necessary

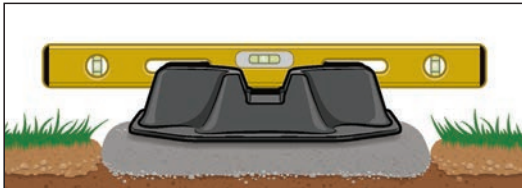

## Quick Installation

If you're in a dry environment with level ground, you can opt to not use paver base and follow the steps below.

- 1 Remove grass and loose soil and place BLOCK on level, undisturbed ground

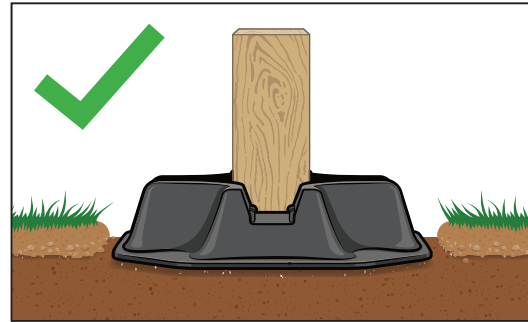

## Installing on Uneven Surfaces

If you're building on an uneven surface, you will need to dig out the ground to ensure BLOCK is sitting on a level surface.

*Never build up the footing beneath the BLOCK.*

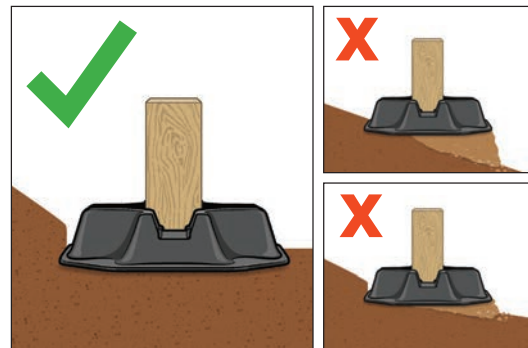

## Deck Heights

You can use BLOCK to build deck substructures 5½ in. to 30 in. tall. **Always check with your local building code officials before starting any project.** Freestanding decks 30 in. tall or less, and smaller than 200 square feet in size, typically do not require building permits.

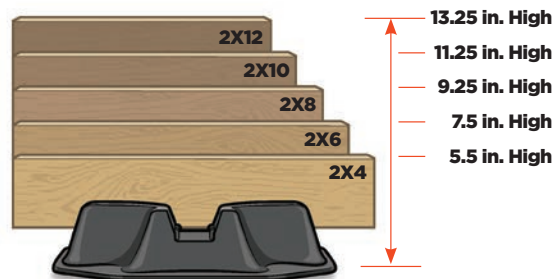

*For final deck height, take into account the thickness of your deck boards as well.*

## BLOCK Spacing

Use CAMO BLOCK throughout various decking projects, spanning a maximum of 60 in. apart and joists spaced at 16 in. on center.

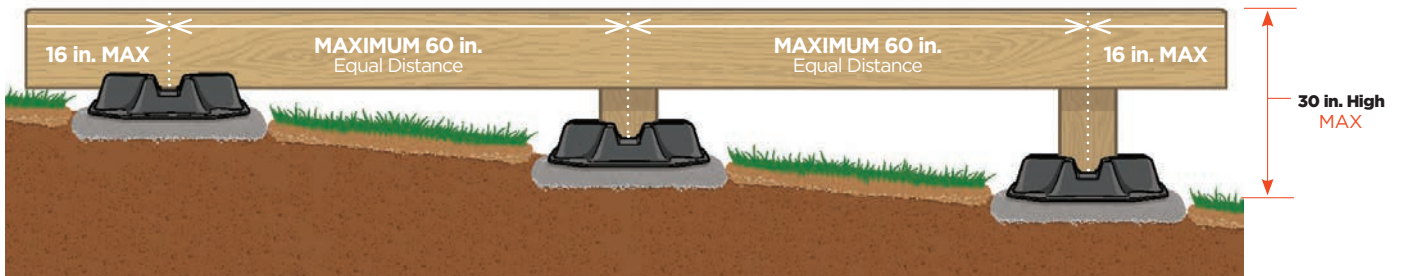
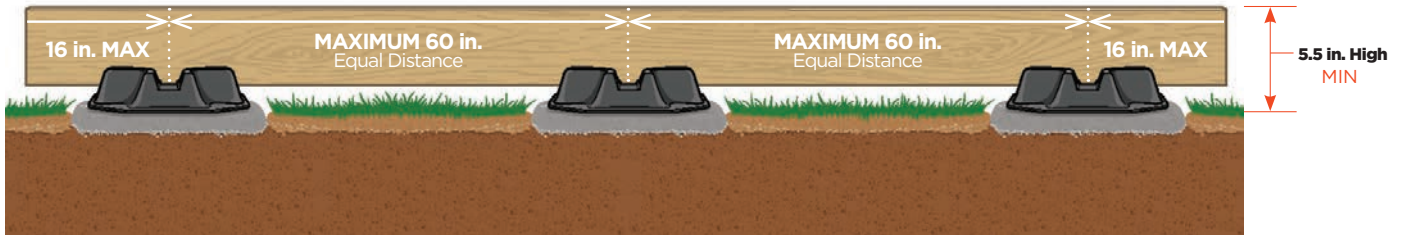

## BLOCK INSTALLATION DONT'S



### Do Not Bury

BLOCK is for above ground use only. It is **NOT** intended as a buried "footing pad" or for use for any other below ground application.



### Do Not Stack

Multiple BLOCKS should **NOT** be stacked during installation to increase deck height.

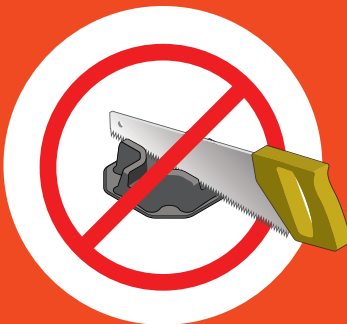

### Do Not Modify, Cut, or Manipulate BLOCK

Unlike concrete blocks that you'd likely have to chip out to make room for joists, you will never have to modify CAMO BLOCK before use—they are ready as is.

Modifying BLOCK in any way, shape, or form may severely detract from its structural integrity and performance and will void the warranty. Failure to adhere to this may lead to damaged property, injury, or death.

## Making a Plan

For a low-profile project, BLOCK will be at ground level, and you will simply run the joists through each BLOCK.

Follow the instructions below to identify how many BLOCKS you'll need for your project.

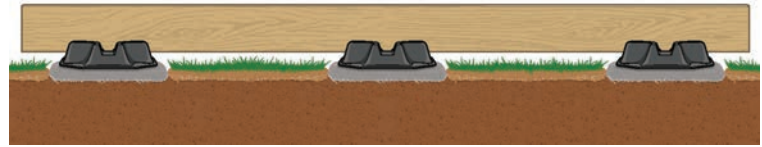

Use BLOCK to build deck substructure as low as 5½ in. tall

- 1 Identify the overall dimensions of the frame



- 2 Locate all joists 16 in. on center

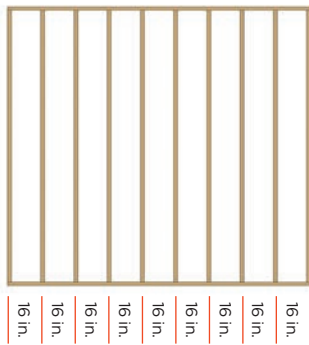

- 3 You will need BLOCKS throughout spanning a maximum of 60 in. apart

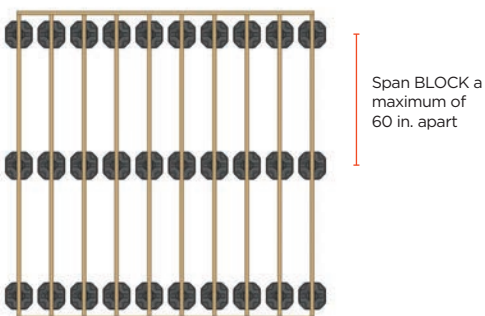

- 4 Add up the number of Blocks.

## Optional: Conceal BLOCKS Under the Deck

If you don't want to see BLOCK in your finished project, follow these steps:

- 1 Remove the BLOCKS supporting the rim joists
- 2 Add wood blocking between the last row of BLOCKS and the rim joist, no more than 16" on center

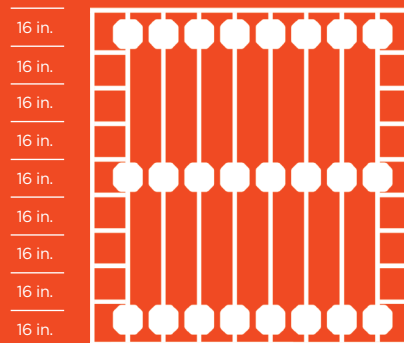

# \_\_\_\_\_ BLOCKS  
FOR YOUR PROJECT

**!** Always check with your local building code officials before starting any project.



## STEP 1

---

Prepare the area where your BLOCKS will go.

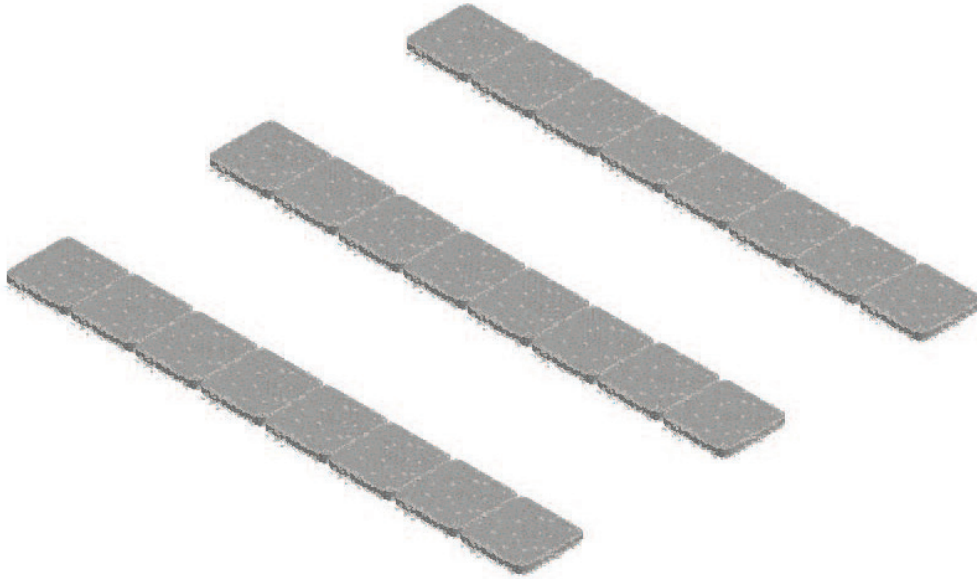

## STEP 2

---

Lay out each BLOCK where needed.



## STEP 3

---

Box-in the frame, leveling and adjusting as you go.

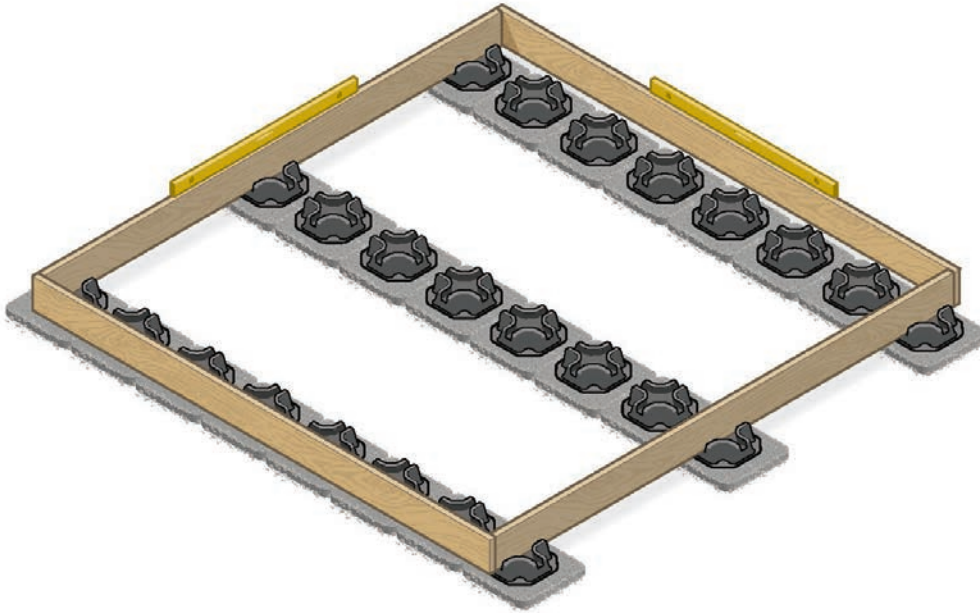

## STEP 4

---

Install all joists. For the best practice installation, use joist hangers.

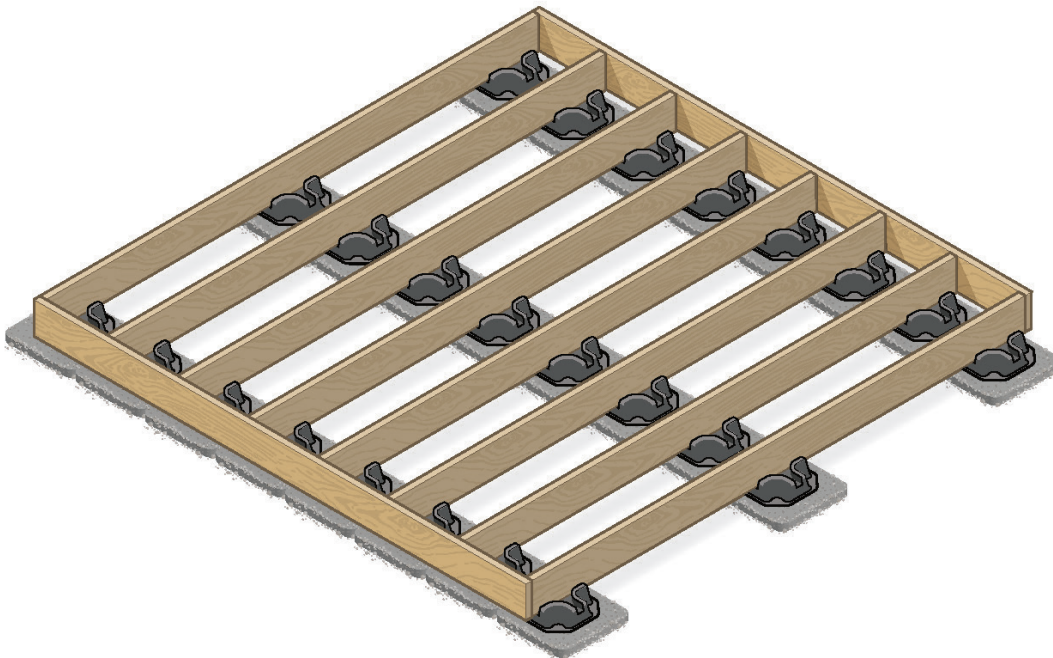

## STEP 5 (OPTIONAL)

Conceal BLOCKS by removing the BLOCKS supporting the rim joists and adding wood blocking between the existing BLOCKS and rim joist, no more than 16" on center.

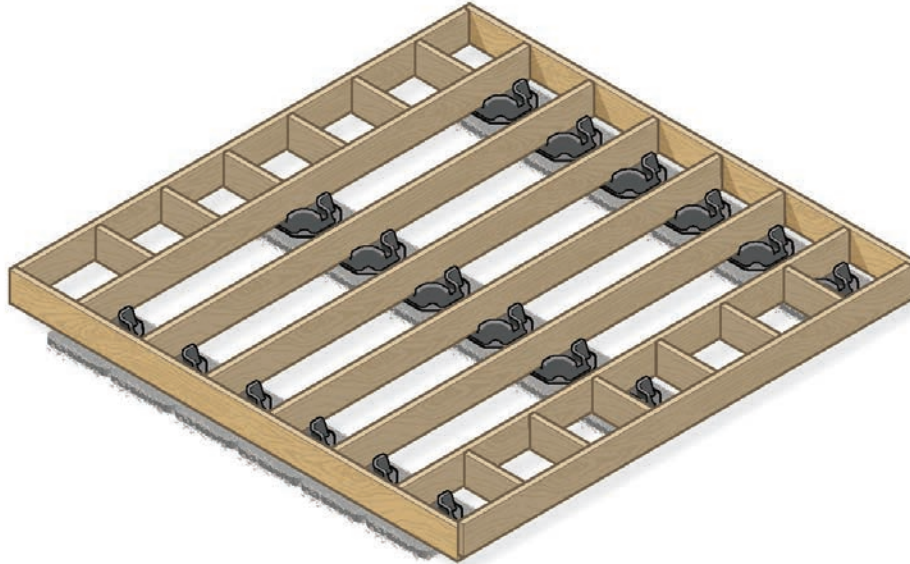

## STEP 6

Install the decking of your choice. Be sure to check out the full line of CAMO deck fasteners and tools to get the job done smarter, faster, easier, and better.

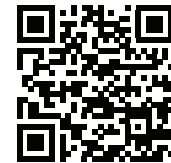
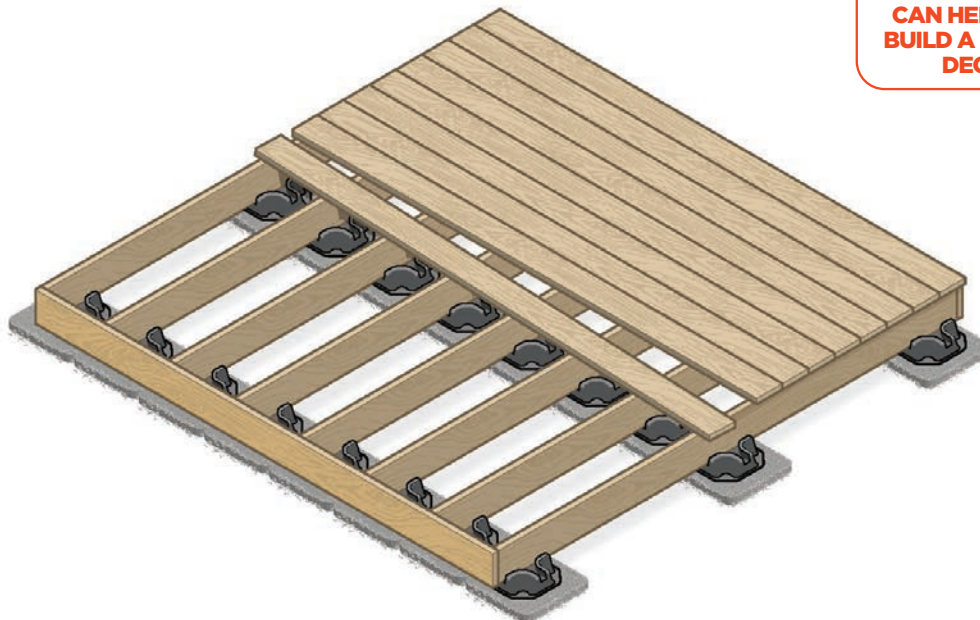

**LEARN HOW CAMO  
CAN HELP YOU  
BUILD A BETTER  
DECK.**



## Making a Plan

For a raised-profile project that's 12-30 in. high, you will use posts, beams, and joists in your framing. Be sure to check local codes and load-bearing specifications for necessary beam locations.

Follow the instructions below to identify how many BLOCKS you'll need for your project.

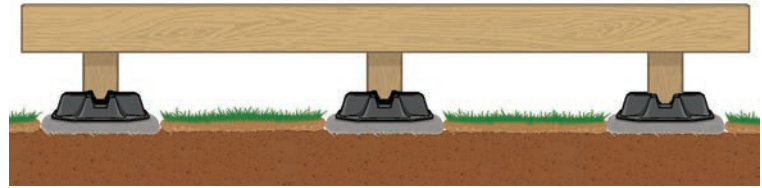

Use BLOCK on Raised-Profile decks 12-30 in. tall

- 1 Identify the overall dimensions of the frame

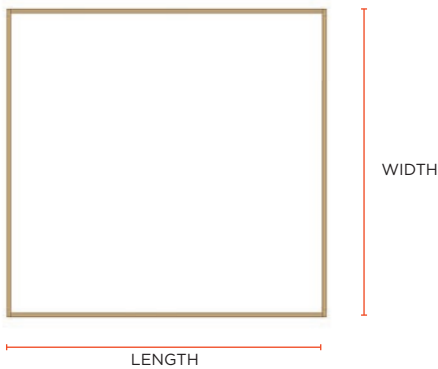

- 2 Using joist hangers, locate all joists 16 in. on center

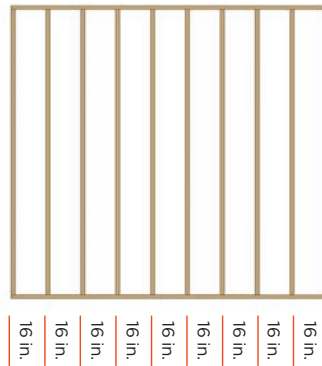

- 3 Check local codes and structural specs to identify where your beams and posts will be located

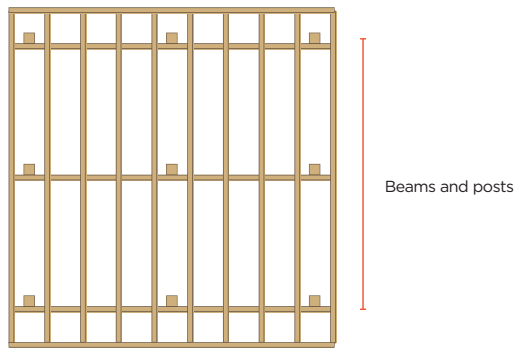

- 4 You will need BLOCKS throughout spanning a maximum of 60 in. apart

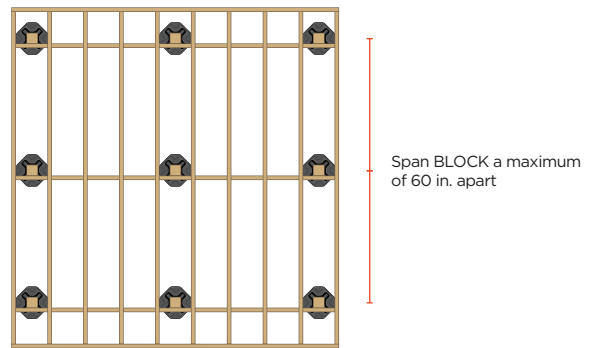

- 5 Add up the number of BLOCKS.

# \_\_\_\_\_ BLOCKS  
FOR YOUR PROJECT



Always check with your local building code officials before starting any project.

## STEP 1

---

Prepare the area where your BLOCKS will go.

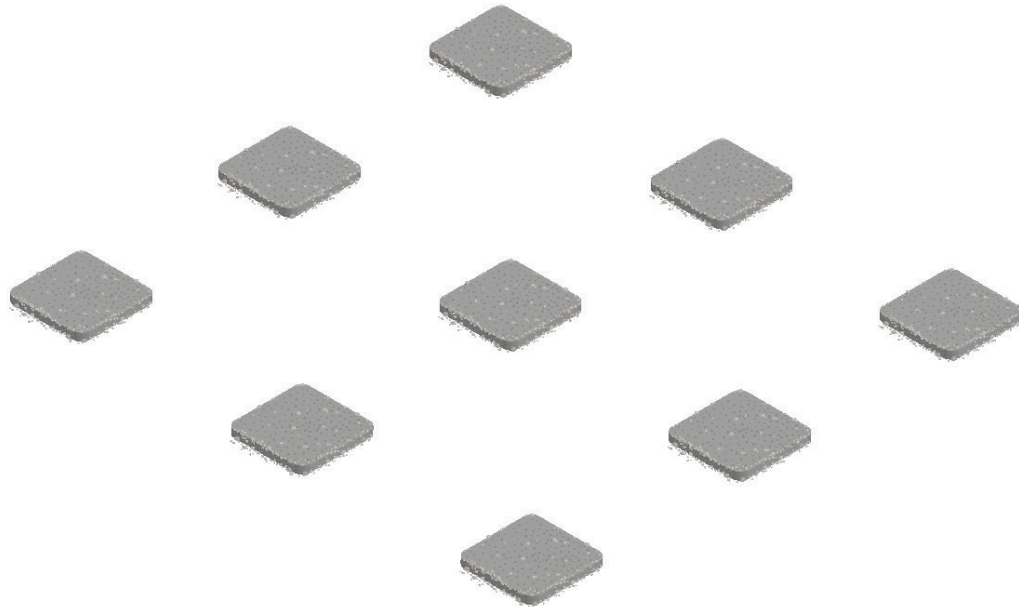

## STEP 2

---

Starting on one side where your outer joist will be, place a BLOCK in each corner.

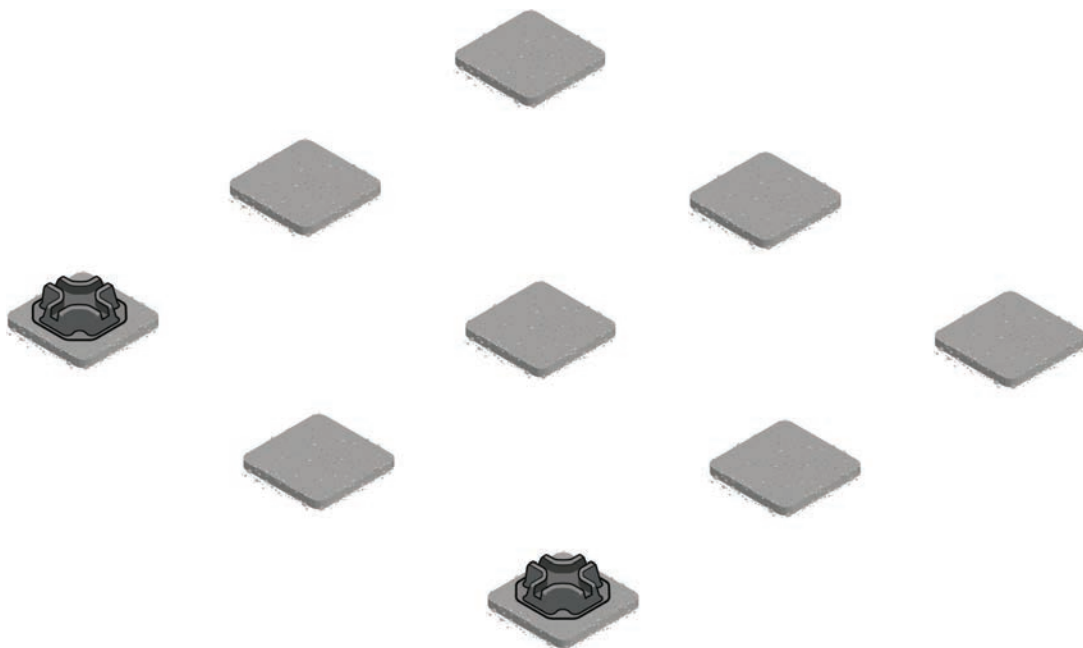

## STEP 3

Place your posts and beam at the desired height taking into consideration the height of your joists and deck boards. Make sure everything is level.

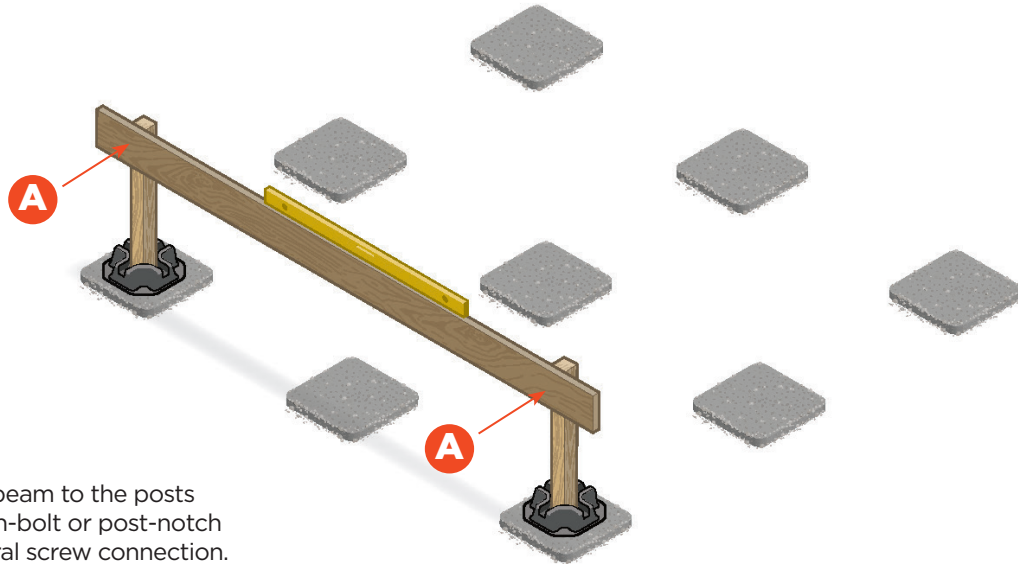

- A** Connect your beam to the posts using a through-bolt or post-notch CAMO structural screw connection.

## STEP 4

Place a BLOCK at each of the remaining corners. Set your posts and clamp a beam to hold it in place.

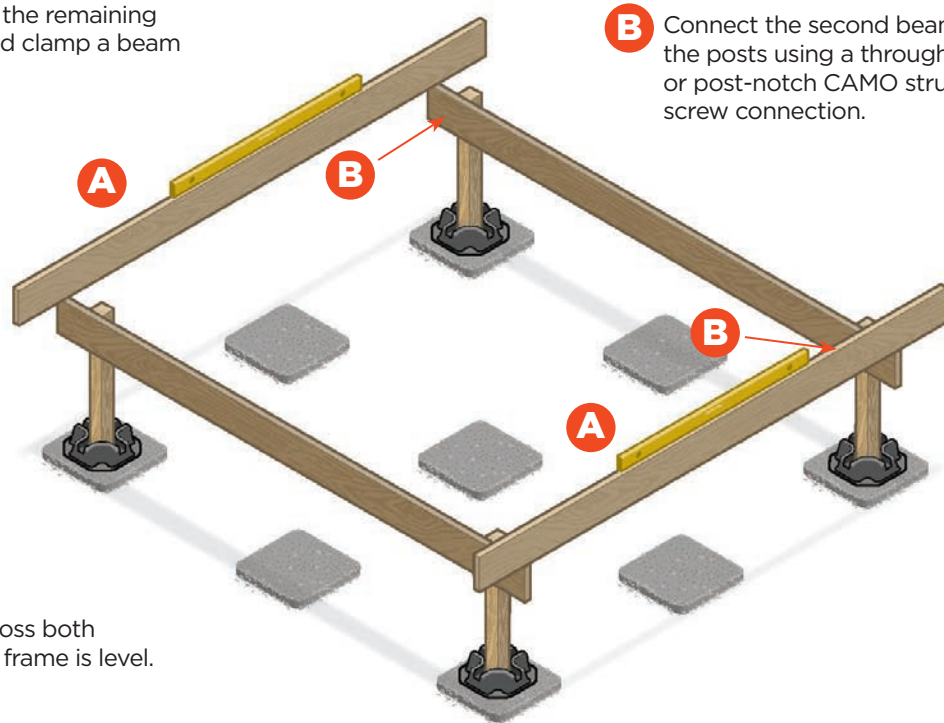

- A** Set your rim joist across both beams to ensure the frame is level.

- B** Connect the second beam to the posts using a through-bolt or post-notch CAMO structural screw connection.



## STEP 5

Add additional BLOCK, post, and beams according to spacing and your local code requirements, ensuring they are level.

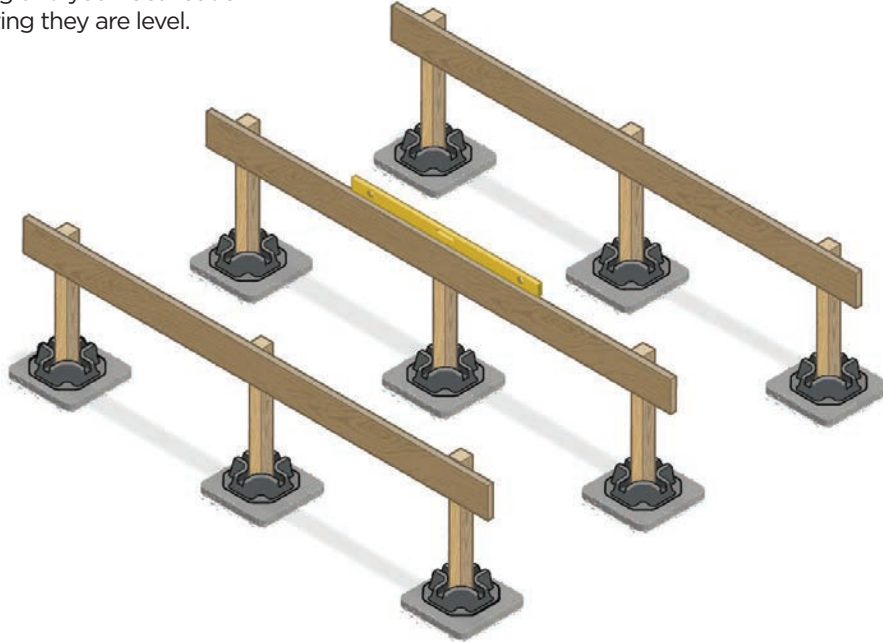

## STEP 6

Finish building the frame by attaching the outer joists to the rim joists.

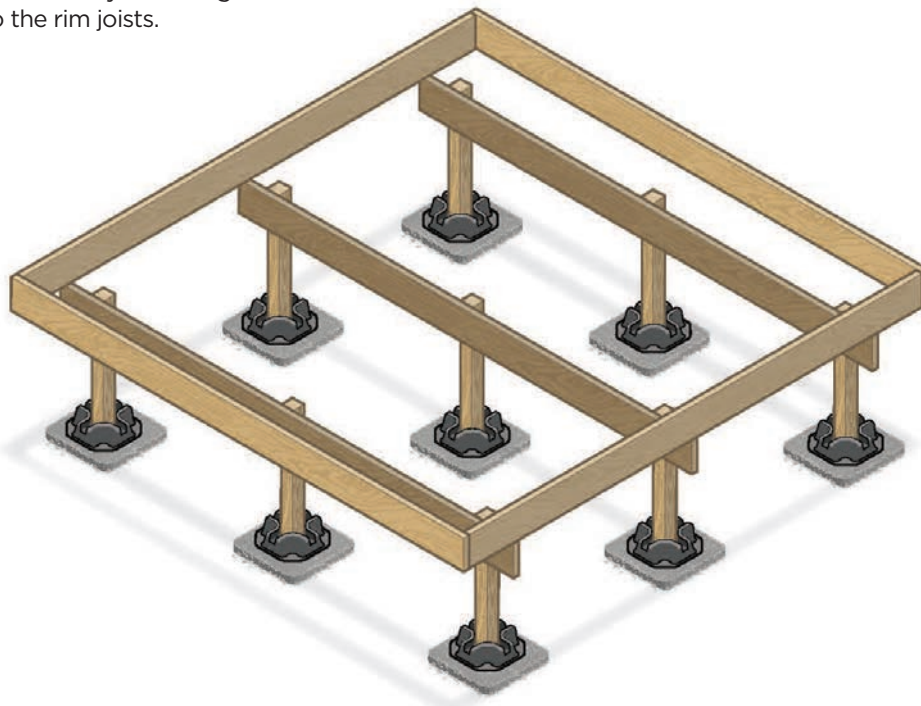

## STEP 7

Install all joists. For the best practice installation, use joist hangers.

**Check local codes for beam to joist connections.**

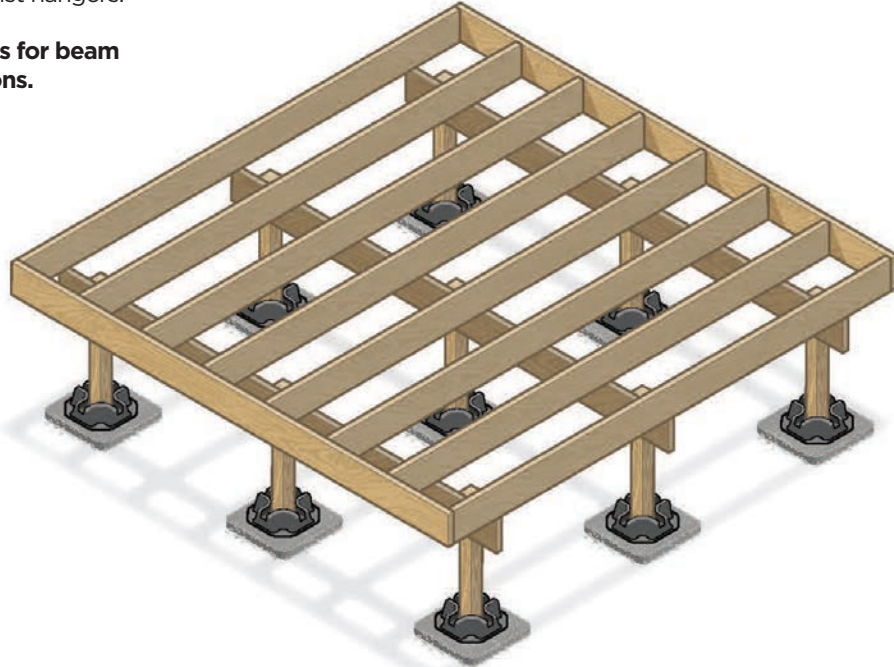

## STEP 8

Install the decking of your choice. Be sure to check out the full line of CAMO deck fasteners and tools to get the job done smarter, faster, easier, and better.

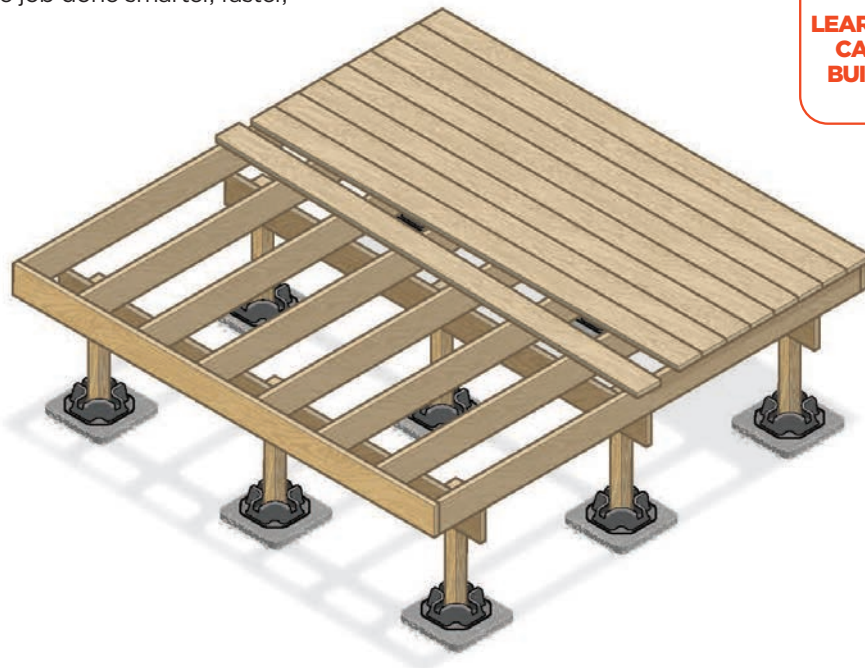

**LEARN HOW CAMO  
CAN HELP YOU  
BUILD A BETTER  
DECK.**

## Making a Plan

For a variable-height project, you will use posts, beams at various heights, and joists in your framing. Be sure to check local codes and load-bearing specifications for necessary beam locations.

Follow the instructions below to identify how many BLOCKS you'll need for your project.

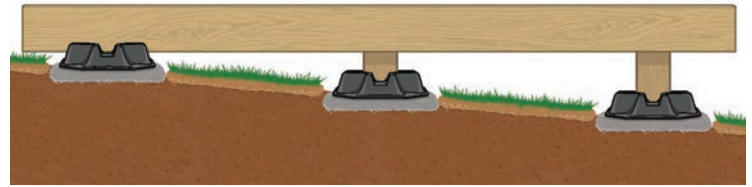

Use BLOCK on variable-height decks with posts and beams at various heights

- 1 Identify the overall dimensions of the frame

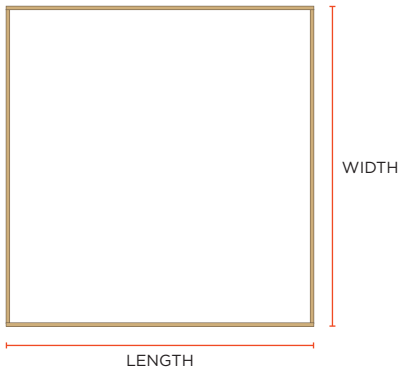

- 2 Locate all joists 16 in. on center

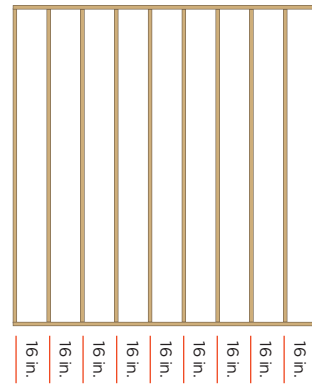

- 3 Check local codes and structural specs to identify where your beams and post piers will be located

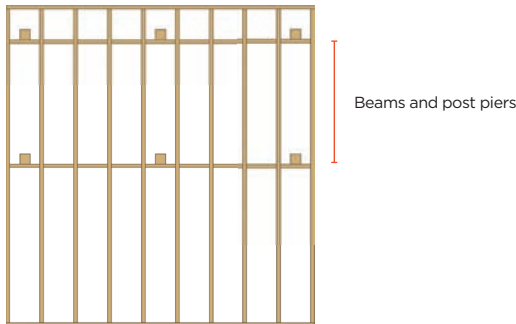

- 4 You will need BLOCKS along each post pier spanning a maximum of 60 in. apart

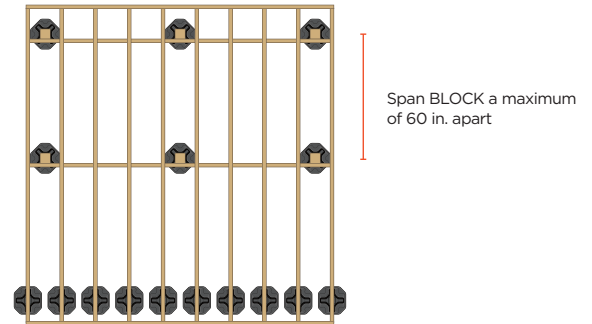

- 5 Add up the number of BLOCKS.



# \_\_\_\_\_ BLOCKS  
FOR YOUR PROJECT

**!** Always check with your local building code officials before starting any project.

### Optional: Conceal BLOCKS Under the Deck

If you don't want to see BLOCK in your finished project, follow these steps:

- 1 Remove the BLOCKS supporting the rim joists
- 2 Add wood blocking between the last row of BLOCKS and the rim joist, no more than 16" on center

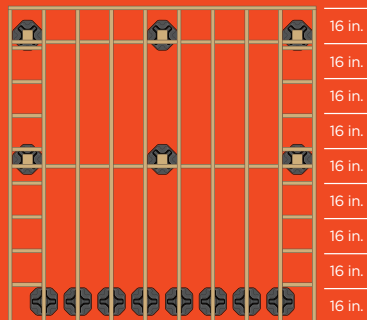



## STEP 1

---

Prepare the area where your BLOCKS will go.

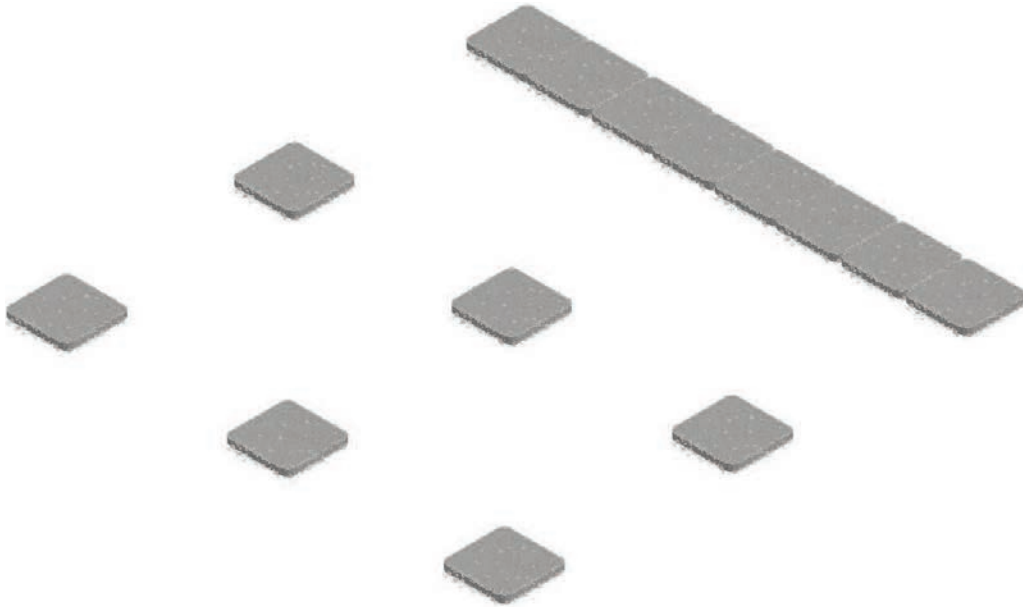

## STEP 2

---

Starting at the lowest end of your project, place a BLOCK in each corner.

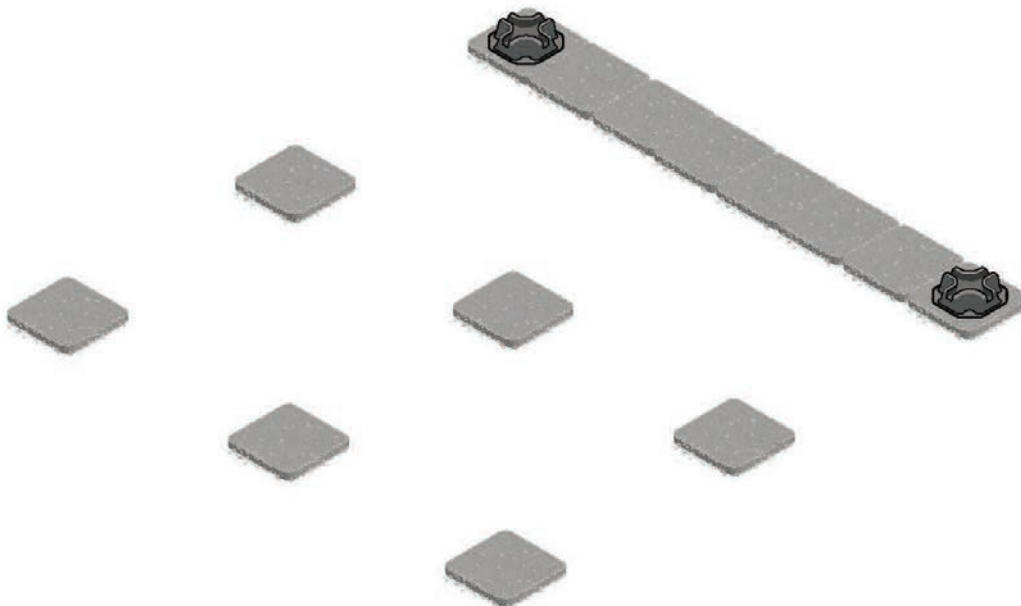

### STEP 3

Place a rim joist between these two BLOCKS making sure it's level.

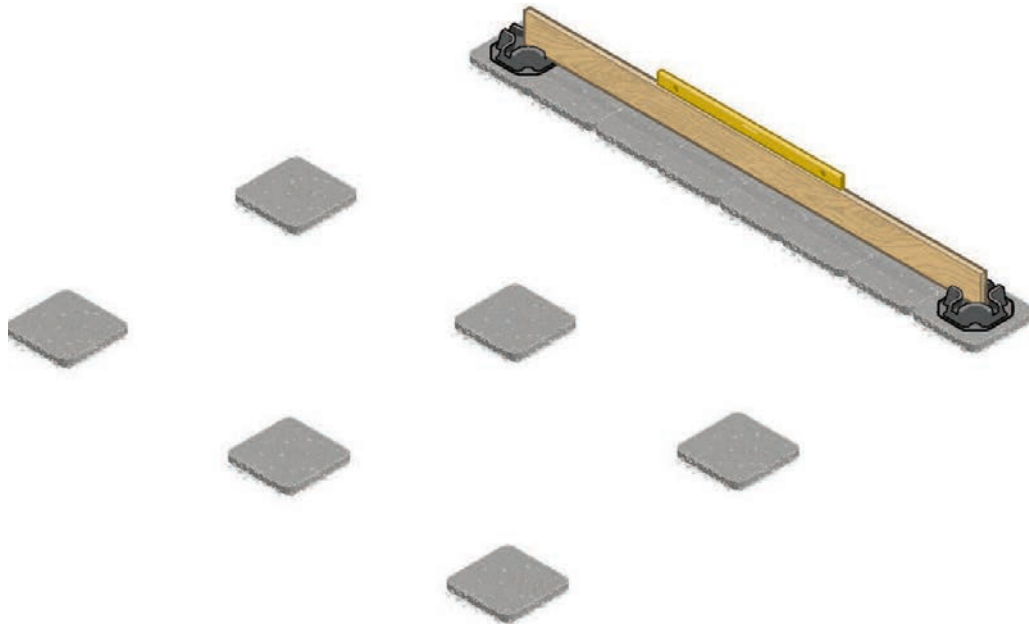

### STEP 4

Move to the highest end of the project and place a BLOCK in each corner.

**B** Run the outer joists from the low side to the high side of the project, adjusting the height of the beam until joists are level, then connect joists together.

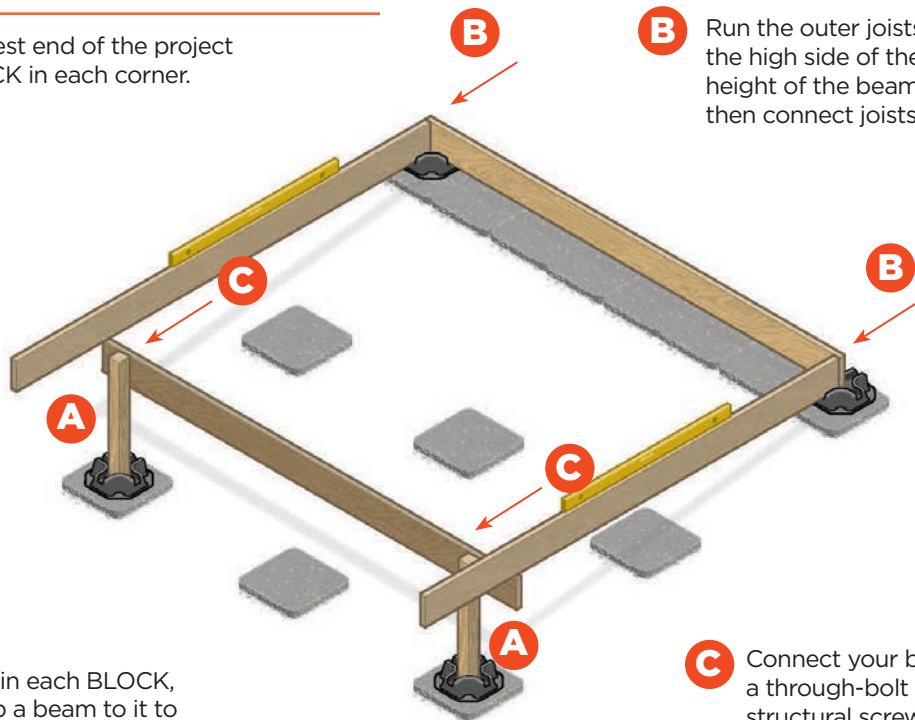

**A** Set a post in each BLOCK, then clamp a beam to it to hold it in place.

**C** Connect your beam to the posts using a through-bolt or post-notch CAMO structural screw connection.

## STEP 5

Lift lower end of frame and slide so outer joists are supported by BLOCKS.

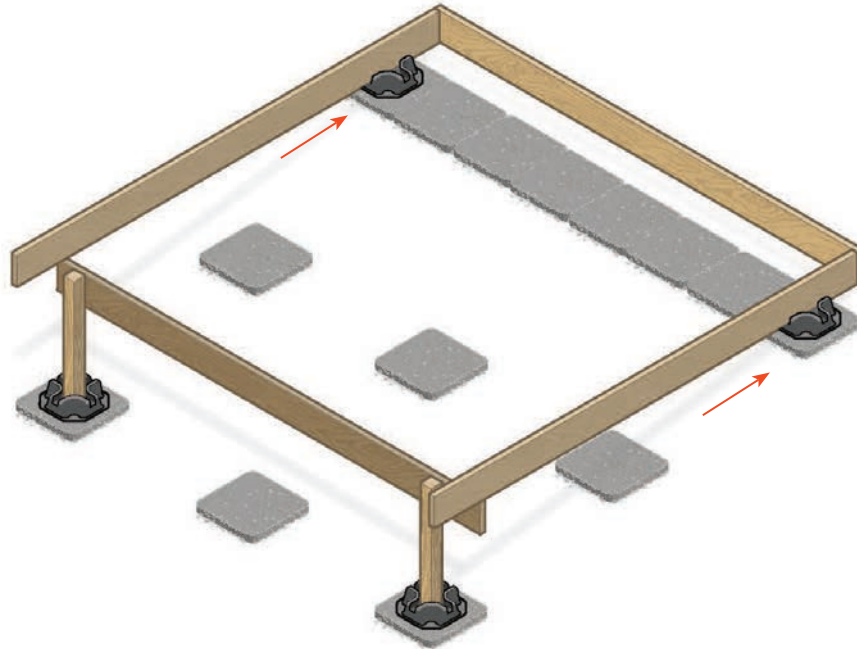

## STEP 6

Attach the final outer joist to the rim joists to finish the frame.

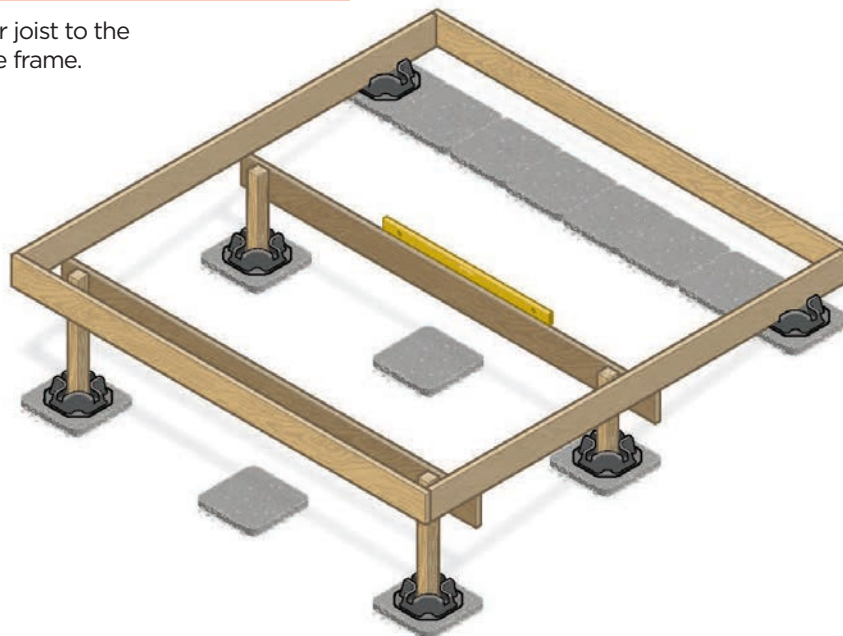



## STEP 7

With the frame in place, set all BLOCKS, posts, and beams according to spacing and local code requirements.

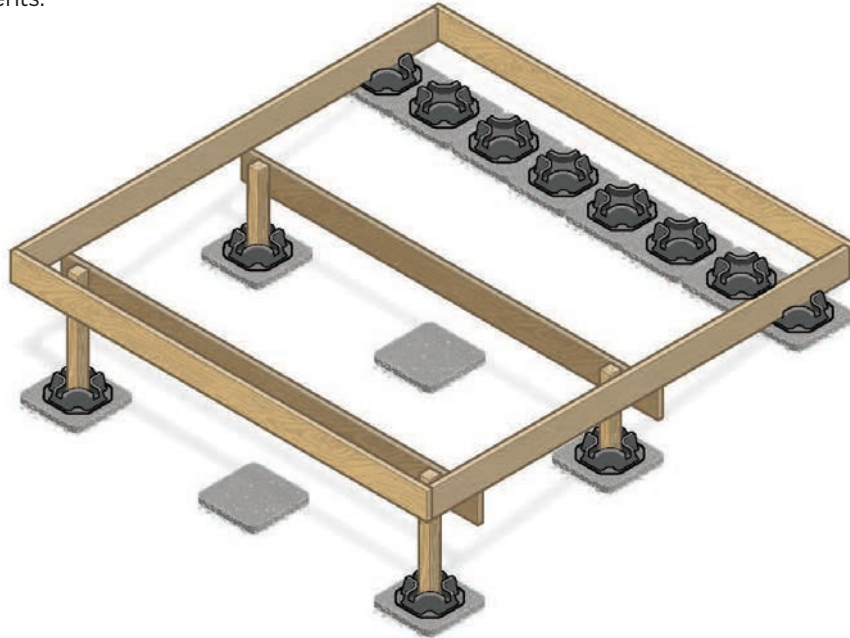

## STEP 8

Install the joists on top of the beams. For the best practice installation, use joist hangers.

**Check local codes for beam to joist connections.**

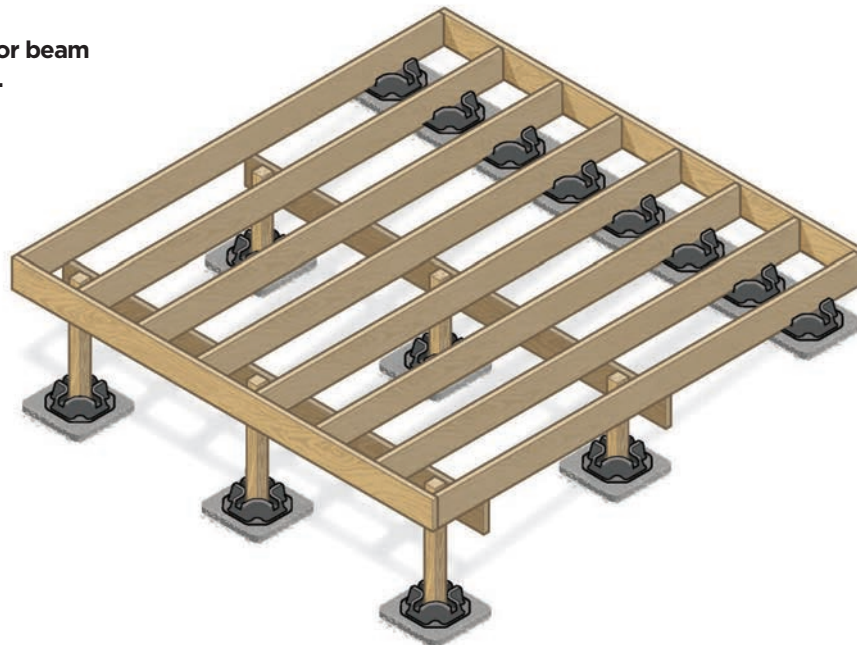

## STEP 9 (OPTIONAL)

Conceal BLOCKS by removing the BLOCKS supporting the rim joists and adding wood blocking between the existing BLOCKS and rim joist, no more than 16" on center.

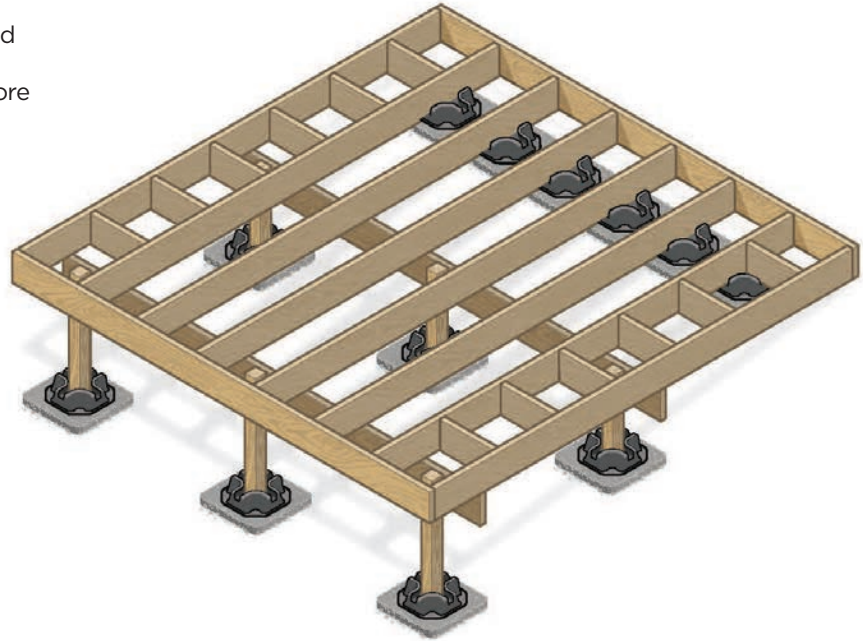

## STEP 10

Install the decking of your choice. Be sure to check out the full line of CAMO deck fasteners and tools to get the job done smarter, faster, easier, and better.



**LEARN HOW CAMO  
CAN HELP YOU  
BUILD A BETTER  
DECK.**

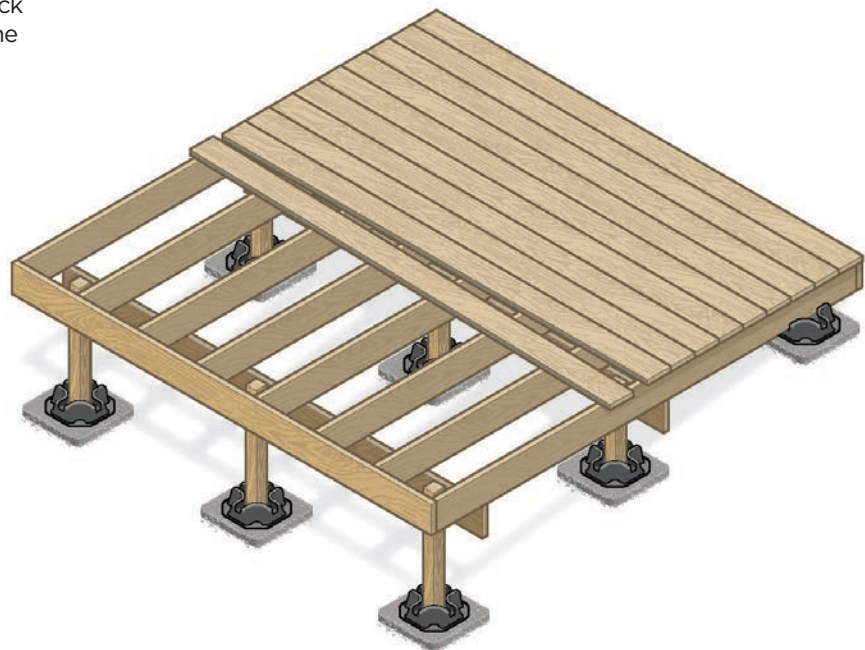

## Making a Plan

For a hybrid project, you will use posts, beams, and joists in your framing, in addition to your concrete footings. Be sure to check local codes and load-bearing specifications for necessary beam locations.

Follow the instructions below to identify how many BLOCKS you'll need for your project.

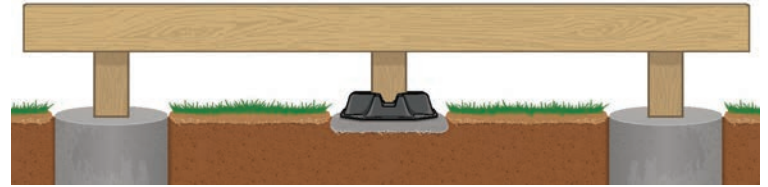

Use BLOCK along with concrete footings on Hybrid-Profile decks

- 1 Identify the overall dimensions of the frame

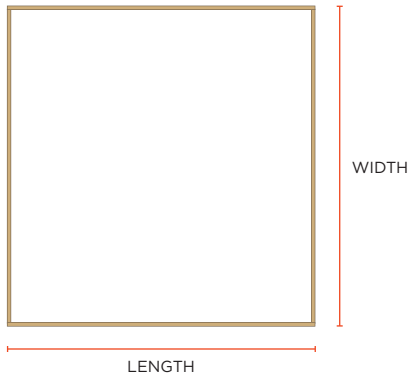

- 2 Locate all joists 16 in. on center

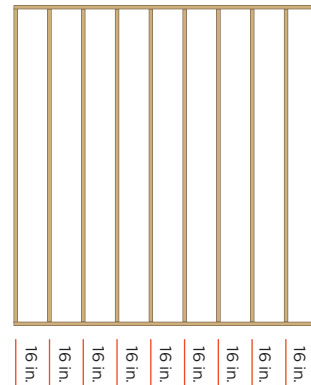

- 3 Check local codes and structural specs to identify where your beams and concrete footings would be located

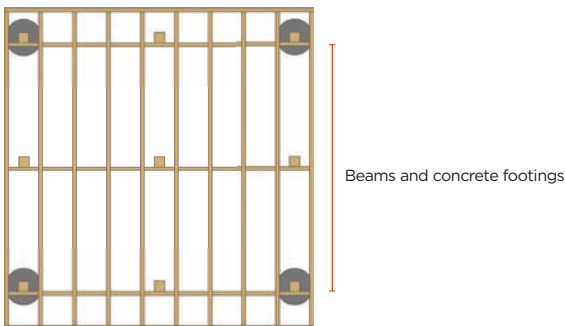

- 4 You will need BLOCKS along each post pier spanning a maximum of 60 in. apart

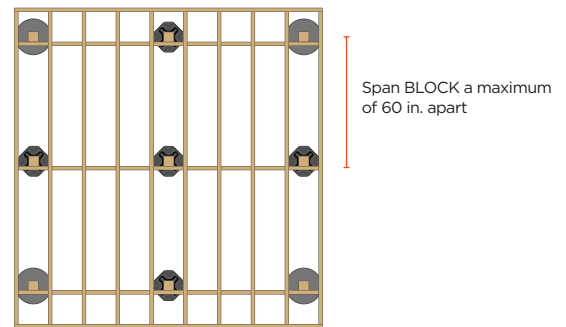

- 5 Add up the number of BLOCKS.

# \_\_\_\_\_ BLOCKS  
FOR YOUR PROJECT

**!** Always check with your local building code officials before starting any project.



## STEP 1

---

Establish your concrete footings.

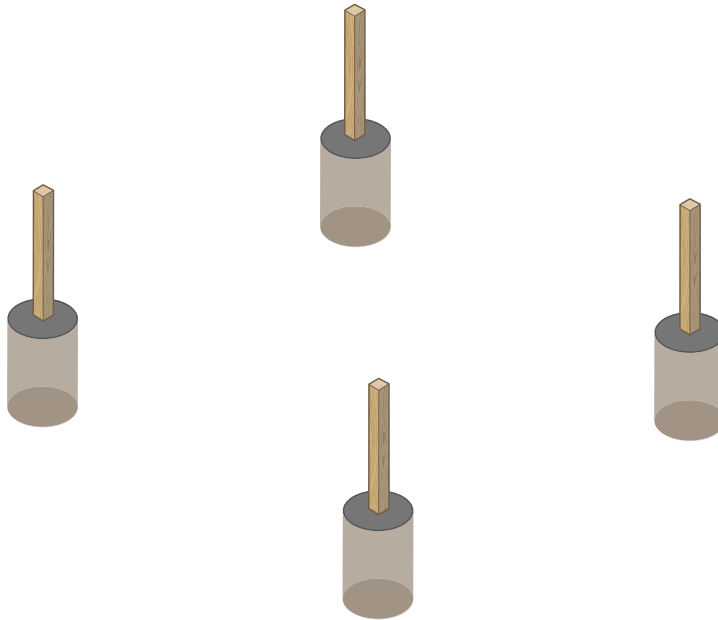

---

## STEP 2

Prepare the area where your BLOCKS will go.

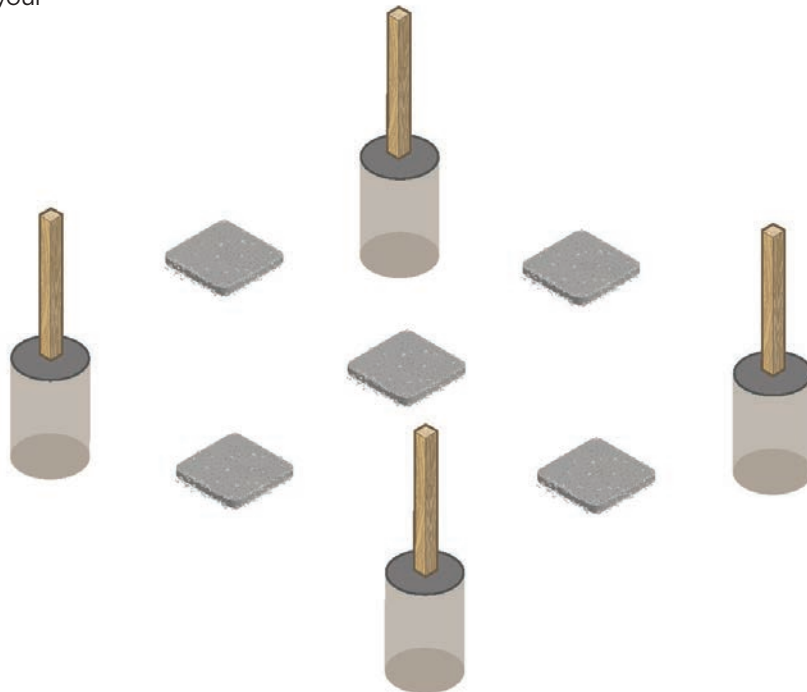

## STEP 3

Place and level your first beam across two concrete footings. Repeat on the other side.

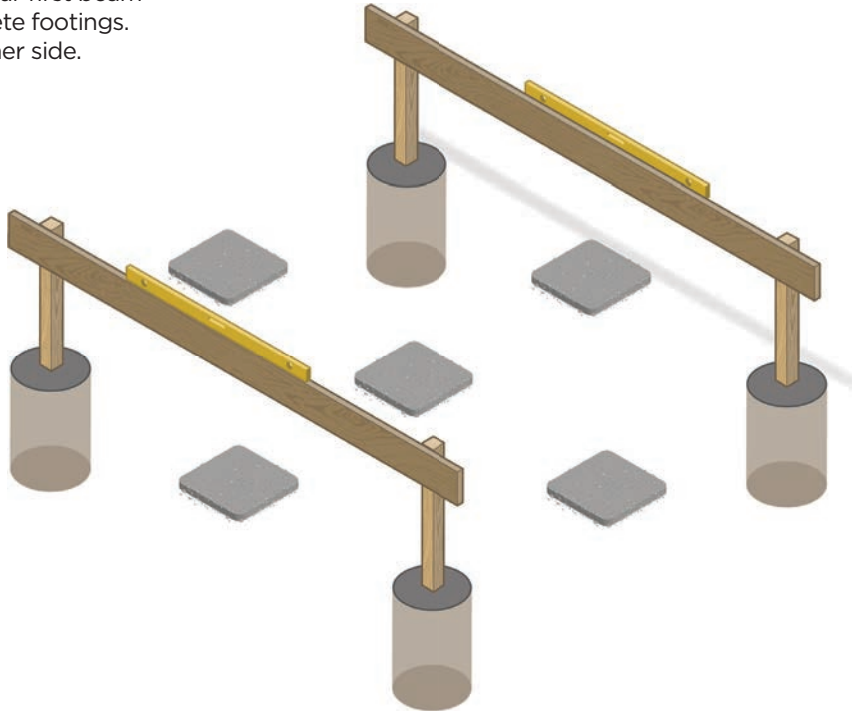

## STEP 4

Place and level your rim joists and attach them to the beam.

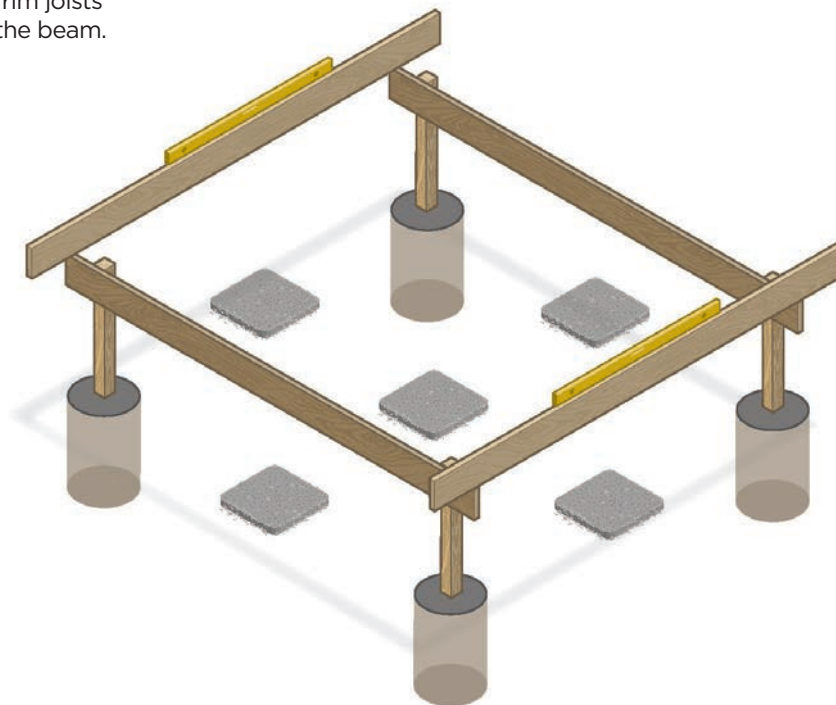

## STEP 5

Attach the outer joists to the rim joists to finish the frame.

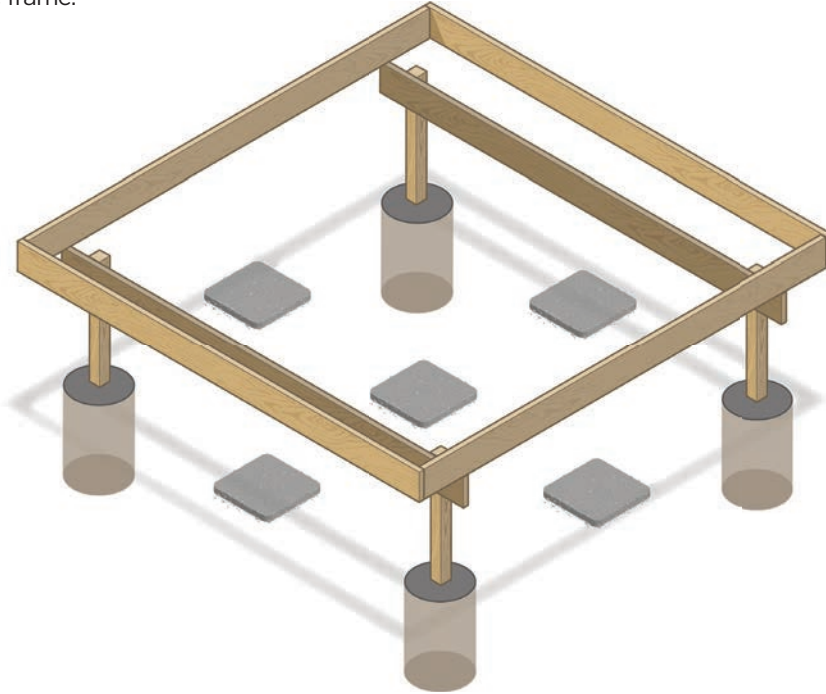

## STEP 6

Place BLOCKS and posts in between the concrete footings to install another beam.

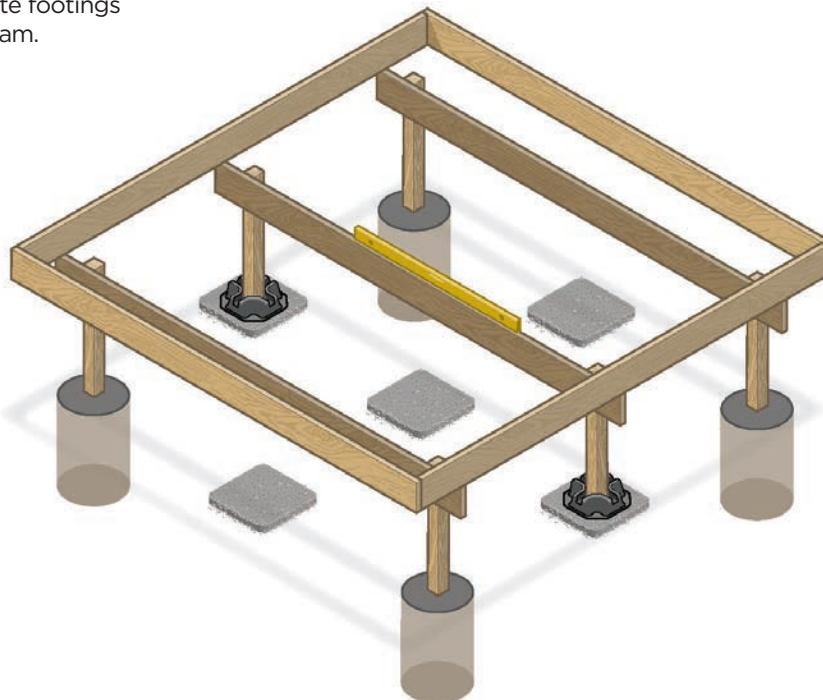

## STEP 7

---

Add remaining BLOCKS and posts to the beams and secure using a through-bolt or post-notch CAMO structural screw connection.

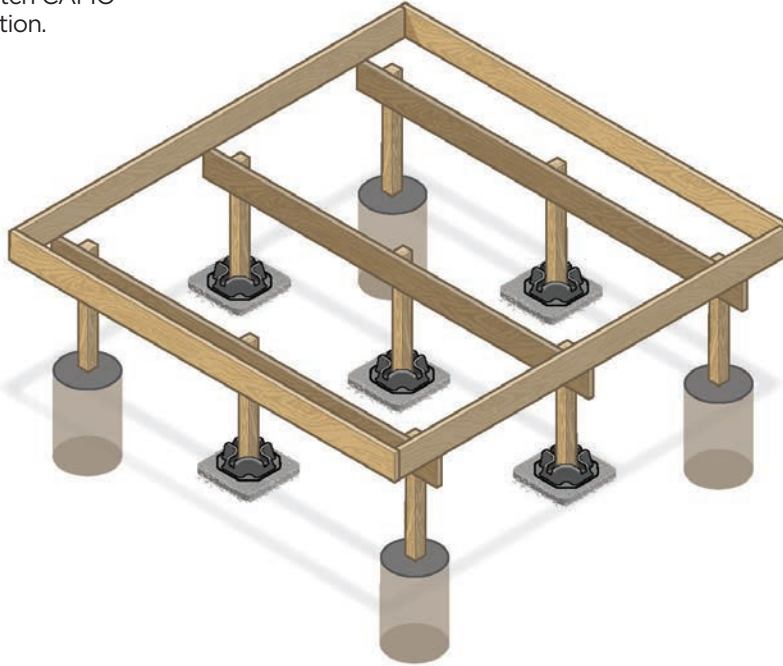

## STEP 8

---

With all posts and beams in place, install all joists. For the best practice installation, use joist hangers.

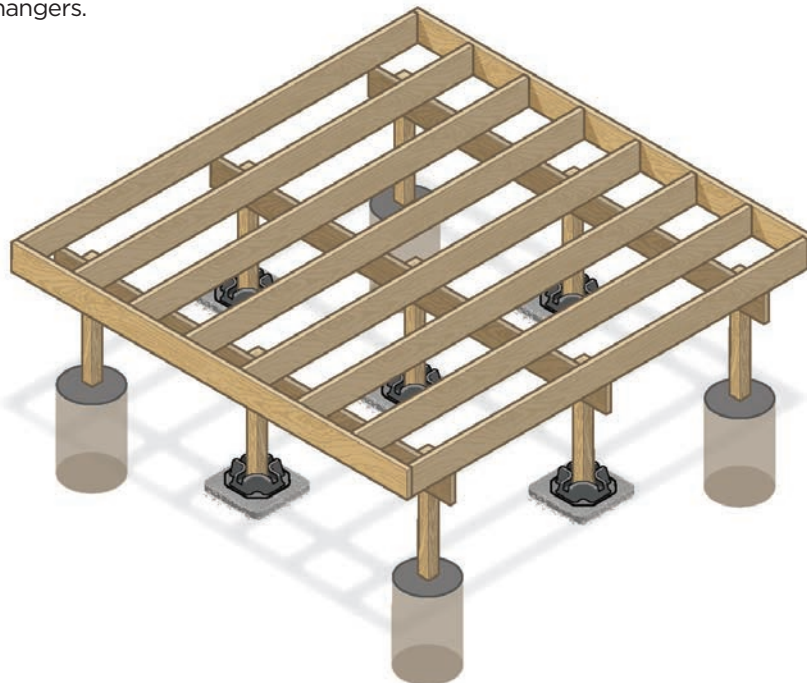



## STEP 9

---

Install the decking of your choice. Be sure to check out the full line of CAMO deck fasteners and tools to get the job done smarter, faster, easier, and better.

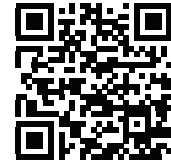
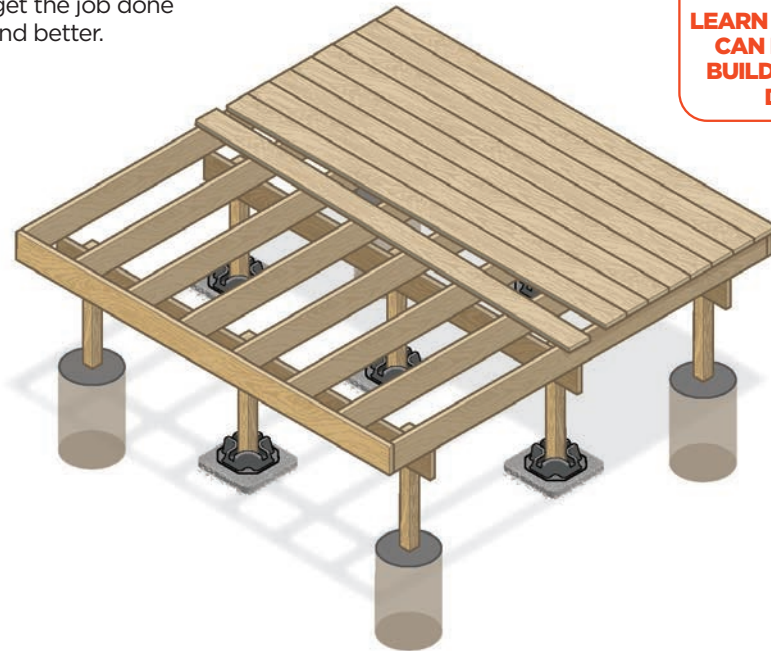

**LEARN HOW CAMO  
CAN HELP YOU  
BUILD A BETTER  
DECK.**